

Custom Expansion Joint

Type: **AEJ-5**

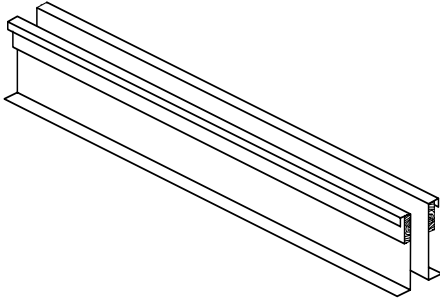

Adaptable Air Products

910 Creekside Road, Chattanooga, TN 37406
 Phone: (423) 698-1003 ~ Fax: (423) 622-4002
 Toll Free: 1-866-227-4462

Features:

- ✓ Pre installed pressure treated wood nailer
- ✓ Fully welded galvanized steel shell
- ✓ All welds coated after fabrication

Customer: _____

Order Date: _____

Project: _____

Date Required: _____

Ship To: _____

Special Instructions

Customer PO#: _____

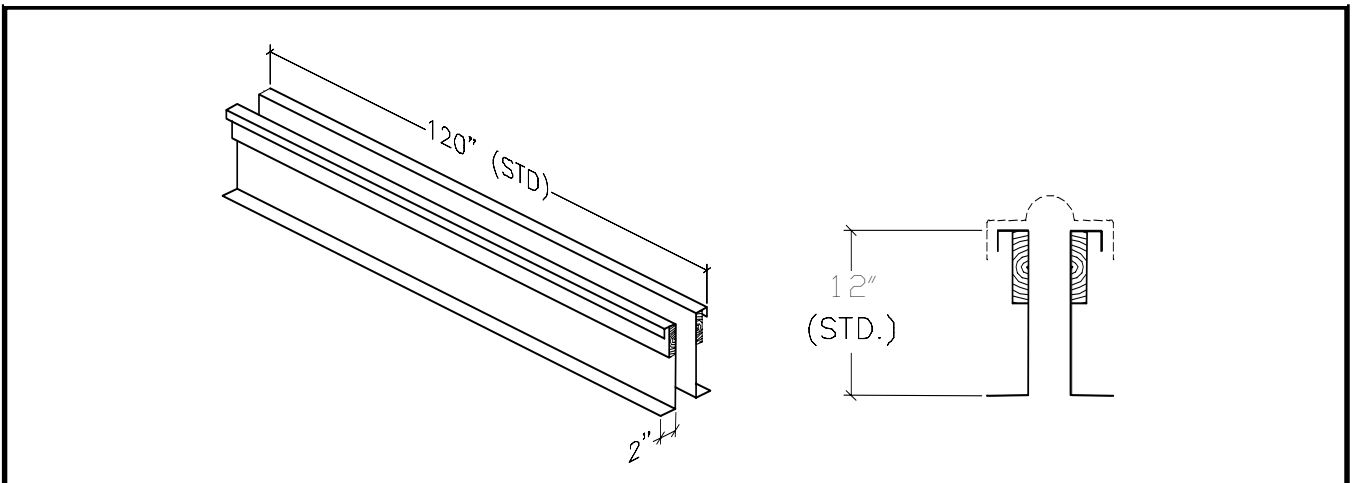

TAG	Number Required	Length	Height