

# Equipment Supports

Type: **ES-3**



**Adaptable Air Products**

910 Creekside Road, Chattanooga, TN 37406  
 Phone: (423) 698-1003 ~ Fax: (423) 622-4002  
 Toll Free: 1-866-227-4462

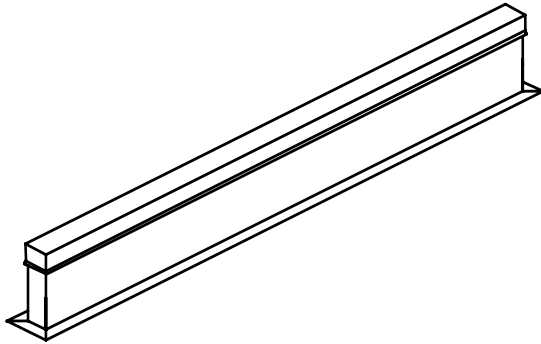

**Features:**

- ✓ Pre installed pressure treated wood nailer
- ✓ Fully welded 18 ga. galvanized steel shell, base plate, and counter flashing.
- ✓ Mitered corners, fully welded
- ✓ All welds coated after fabrication
- ✓ Internal reinforcements

**Customer:** \_\_\_\_\_  
 \_\_\_\_\_  
 \_\_\_\_\_

**Order Date:** \_\_\_\_\_

**Project:** \_\_\_\_\_

**Date Required:** \_\_\_\_\_

**Ship To:** \_\_\_\_\_  
 \_\_\_\_\_  
 \_\_\_\_\_  
 \_\_\_\_\_

**Special Instructions**

**Customer PO#:** \_\_\_\_\_

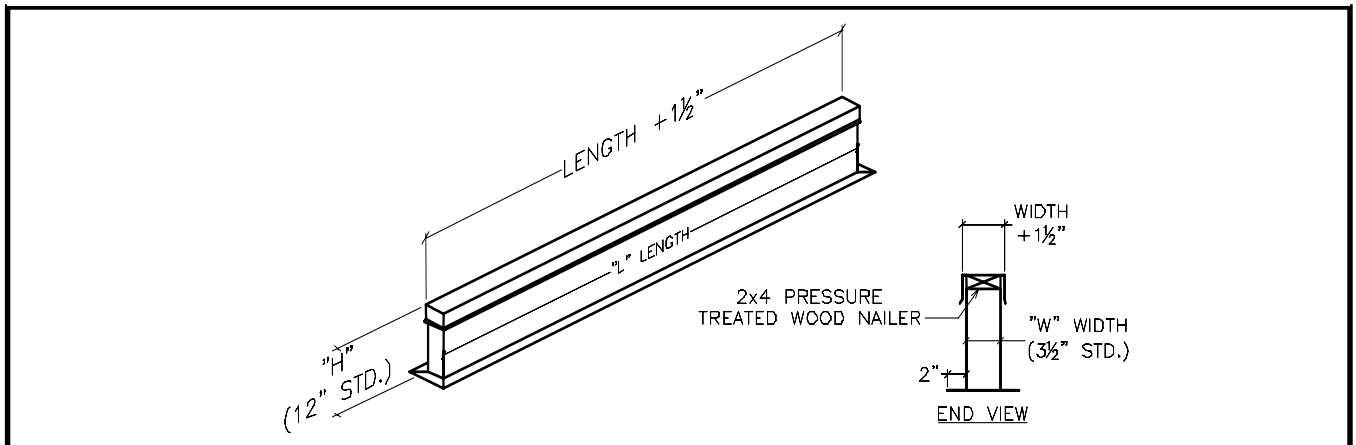

TAG	Number Required	L	W	H